



**ROURA**  
MATERIAL HANDLING

Michigan: (800) 968-9070

Mississippi: (800) 654-9147

[rouramh.com](http://rouramh.com)

## RRB-10-405 (RUGGED ROTATOR BOX)

MODEL #	L	W	H	WEIGHT
RRB-10-405	37"	58"	41 1/4"	390 LBS

The Rugged Rotator Box is designed for the collection and storage of bulk and scrap material. This box can be dumped using a forklift equipped with a rotational fork attachment. The standard model is made of all welded carbon steel with drain plug and 2-way fork entry.

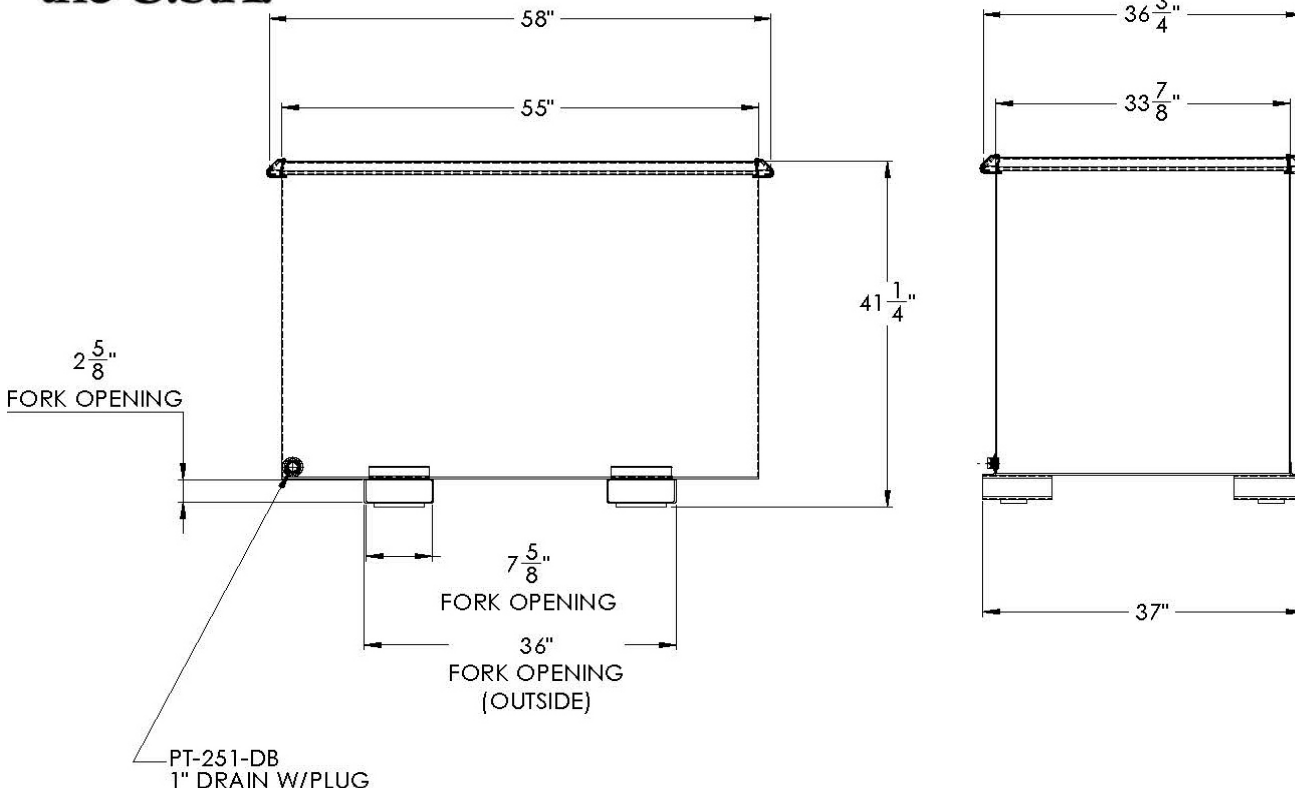
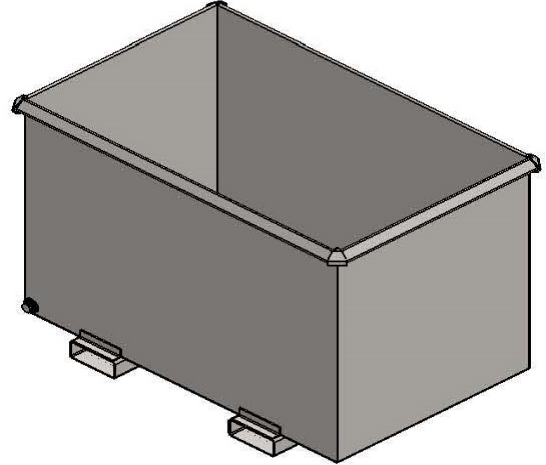

- 10 GAUGE STEEL BOTTOM, 10 GAUGE STEEL FORMED SIDES. STRUCTURAL BOX TUBE FORK OPENINGS FOR SUPERIOR STRENGTH WITH SKID RESISTANCE PLATES.
- 4000 LBS. MAX LOAD CAPACITY.
- BRIGHT SAFETY GREEN ENAMEL PAINT.
- STACKABLE (3 EMPTY BOXES HIGH RECOMMENDED).
- OPTIONS: PLASTIC LID, CASTERS, 4-WAY ENTRY BASE, CRANE EYES, TARPS, CUSTOM COLORS.
- CUSTOM SIZES ARE AVAILABLE UPON REQUEST.

**"FOR ALL YOUR MATERIAL HANDLING NEEDS!"**